

GLASS PANEL #:  
N/A

PIECE COUNT:  
N/A



DRAWN BY:  
JJJ

DATE:  
5/3/2019

GLASS THICKNESS:  
1/2" OR 9/16"

GLASS TYPE:  
LAMINATED OR TEMPERED

SYSTEM HEIGHT:  
36" / 39" / 42"

CUSTOMER APPROVAL REQUESTED:  
N/A

SIZE:  
A

SCALE:  
.0625

ORDER NUMBER:  
N/A

REV:

2

1

2



1

GLASS SURFACE MOUNT TALON SPIGOT INCLUDES:

- 1 MAIN ASSEMBLY
- MALE / FEMALE PRESSURE PLATES
- NYLON INSERTS FOR 1/2 GLASS
- NYLON INSERTS FOR 9/16 GLASS

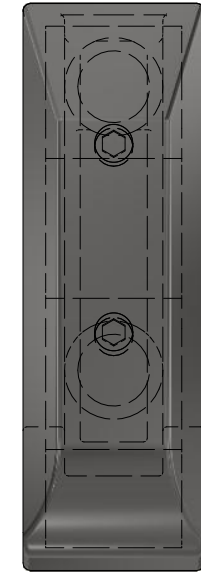
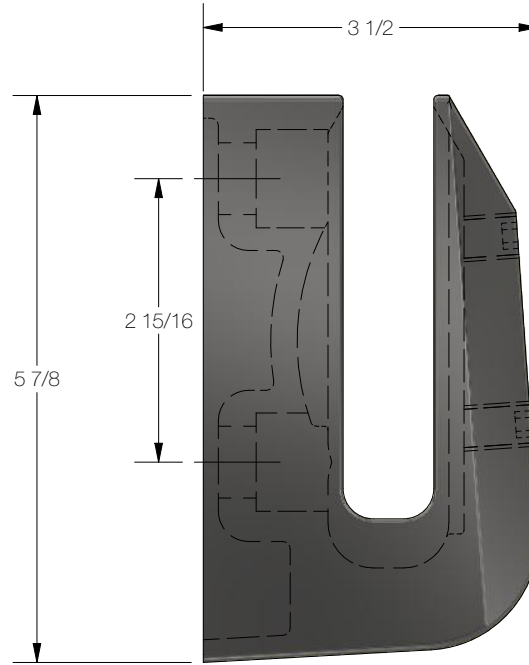
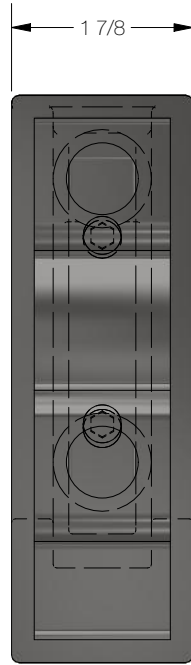

B

B



A

A

		GLASS PANEL #: N/A		PIECE COUNT: N/A			
DRAWN BY: JJJ		DATE: 5/3/2019		GLASS THICKNESS: 1/2" OR 9/16"			
				GLASS TYPE: LAMINATED OR TEMPERED			
				SYSTEM HEIGHT: 36" / 39" / 42"		CUSTOMER APPROVAL REQUESTED: N/A	
SIZE: A		SCALE: 1 / 2		ORDER NUMBER: N/A		REV:	

2



1

2

1

GENERAL NOTES:

1. GLASS THICKNESS IS 1/2" (12mm) OR 9/16" (15mm), AND MUST BE TEMPERED OR LAMINATED SAFETY GLASS.
2. SPECIFICATIONS ARE FOR COMPONENTS ONLY. FASTENING TO THE SUPPORT STRUCTURE IS A SITE CONDITION AND THE INSTALLERS MUST ENSURE THAT THE FASTENERS ARE ADEQUATE TO RESIST THE DESIGN LOADS.
3. THE MATERIAL TO WHICH THE GLASS SUPPORTS ARE BEING FASTENED MUST ADEQUATELY RESIST THE DESIGN LOADS.
4. ALL (2) FASTENING LOCATIONS IN TALON MUST BE POPULATED.
5. 54" MAXIMUM PANEL WIDTH WITH TOP RAIL / CAP
6. 48" MAXIMUM PANEL WIDTH WITHOUT TOP RAIL / CAP

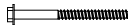

3/8 X 5" SPAX POWER LAG  
HEX WASHER DRIVE

WOOD  
CONCRETE



CONCRETE WEDGE ANCHOR  
3/8 x 3 1/2"

RECCOMENDED FASTENER

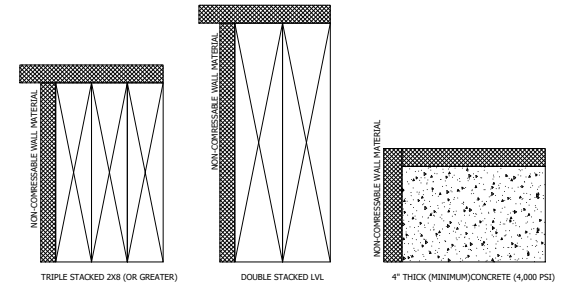

MINIMUM MOUNTING CONDITONS REQUIRED  
SURFACE MOUNT SYSTEM TYPE INSTALLATIONS

B

B

54" MAXIMUM PANEL WIDTH WITH TOP RAIL / CAP  
48" MAXIMUM PANEL WIDTH WITHOUT TOP RAIL / CAP

1" GAP BETWEEN PANELS

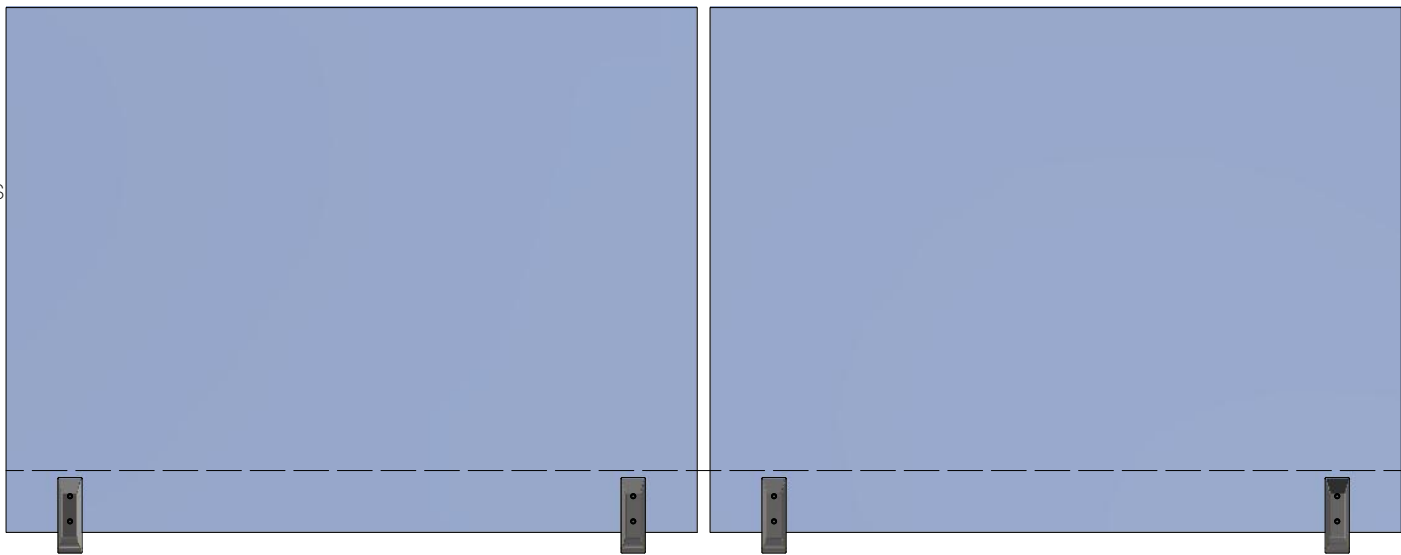

36" / 39" / 42"  
GLASS HEIGHT  
FLOORING TO TOP OF GLASS

PANEL HEIGHT  
DEPENDANT UPON  
MOUNTING HEIGHT OF  
SIDE MOUNT TALON  
(ENGINEER-TO-ORDER)



A

A

		GLASS PANEL #: N/A		PIECE COUNT: N/A			
DRAWN BY: JJJ		DATE: 5/3/2019		GLASS THICKNESS: 1/2" OR 9/16"			
				GLASS TYPE: LAMINATED OR TEMPERED			
				SYSTEM HEIGHT: 36" / 39" / 42"		CUSTOMER APPROVAL REQUESTED: N/A	
		SIZE: A	SCALE: 1/15	ORDER NUMBER: N/A		REV:	

2

1

